

Kalıp Takvimi / KT Mould Dates

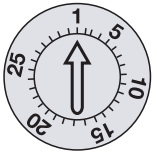

KTG
(GÜN)



KTA
(AY)

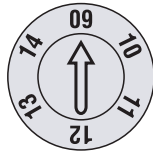

KTY
(YIL)



KTAY
(AY-YIL)

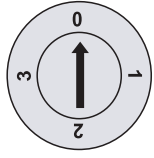

KTV
(VARDİYA)

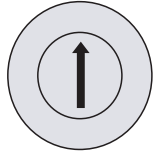

KTO
(BOŞ OK)

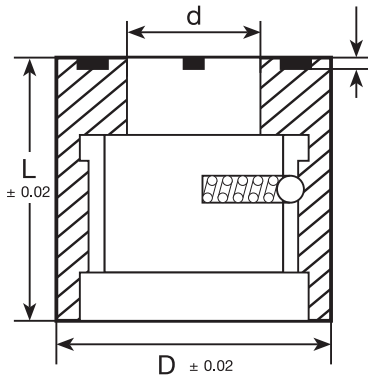

Mevcut Ürünler

Sipariş Şekli Örnek : KTAY x D

D	L	d	E	KTO	KTG	KTA	KTY	KTAY
4	6	2.2	0.10					
5	6	2.5	0.15					
6	8	3	0.20					
8	8	4	0.25					
10	10	4.7	0.35					
12	10	6	0.35					
16	12	7	0.35					
20	14	10	0.35					

Havalı İtici Valfler Air Valves

Standart Tip

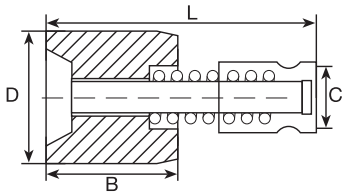

Sipariş Şekli : KOD

KOD	D	B	C	L
HİV 8	8	10	6	27
HİV 10	10	11	6	29
HİV 12	12	11	8	29
HİV 16	16	20	8	42
HİV 18	20	20	8	42
HİV 20	20	20	12	46
HİV 25	25	20	12	52

Jet Tip

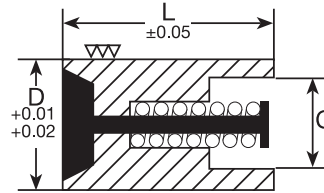

Sipariş Şekli : KOD

KOD	D	C	L
HİJ 6	6	4	12
HİJ 8	8	4,5	15
HİJ 10	10	6	20
HİJ 12	12	8	25
HİJ 16	16	10	30
HİJ 20	20	12	30
HİJ 25	25	15	30